

SPARE PARTS LIST

MODEL NO. UC3520A

ITEM	PART NO.	DESCRIPTION	QTY	NOTE
001	266326-2	TAPPING SCREW 4X18	3	
002	419234-8	REAR COVER	1	
003	191972-1	CARBON BRUSH CB-132	1	
004	682211-5	RUBBER SLEEVE	2	
005	861992-6	UC3520A NAME PLATE	1	
006	421938-0	FRONT GRIP	1	
007	266388-0	TAPPING SCREW 5X16	1	
008	267189-9	FLAT WASHER 5	1	
009	419235-6	FRONT HAND GUARD	1	
010	231640-5	TORSION SPRING 20	1	
011	188089-9	HOUSING SET INC. 62	1	
012	650577-1	SWITCH SD-006-BB2AA-AA	1	
013	651922-3	SWITCH TG71B	1	
014	233173-6	COMPRESSION SPRING 4	1	
015	416178-3	LOCK-OFF BUTTON	1	
016	416708-0	SWITCH LEVER	1	
017	645200-1	NOISE SUPPRESSOR	1	
018	266326-2	TAPPING SCREW 4X18	2	
019	687052-4	STRAIN RELIEF	1	
020	682540-6	CORD GUARD 9.3-90	1	
021	665876-8	POWER SUPPLY CORD 1.0-2-0.6	1	
022	210029-0	BALL BEARING 608ZZ	1	
023	681644-1	INSULATION WASHER	1	
024	594538-0	FIELD ASS'Y 220-240V	1	
025	266389-8	TAPPING SCREW 5X70	2	
026	*****	*****	***	*****
028	419238-0	BAFFLE PLATE	1	
029	211061-7	BALL BEARING 600LLB	1	
030	227153-2	SPUR GEAR 12	1	
031	931403-6	HEX. NUT M8	1	
032	286274-9	CAP	1	
033	421934-8	PACKING	1	
034	419240-3	OIL TANK	1	
035	*****	*****	***	*****
036	*****	*****	***	*****
037	421935-6	OIL TUBE	1	
038	231975-4	SPRING	1	
039	416274-7	CAP	1	
040	256021-2	PIN 5	1	
041	158047-9	LINK PLATE COMPLETE	1	
042	233175-2	COMPRESSION SPRING 9	1	
044	266326-2	TAPPING SCREW 4X18	1	
045	267195-4	FLAT WASHER 4	1	
046	168321-7	BRAKE BAND	1	
047	344688-9	BRAKE RING	1	
048	231817-2	TENSION SPRING 5	1	
049	419236-4	BEARING HOLDER	1	
050	213039-6	O RING 6	1	
051	266326-2	TAPPING SCREW 4X18	4	
052	417405-1	CAM	1	
053	227154-0	SPUR GEAR 43	1	
054	324619-4	SPINDLE	1	
055	210106-8	BALL BEARING 6001LLB	1	
056	*****	*****	***	*****
057	210028-2	BALL BEARING 606ZZ	1	
058	324622-5	ROD	1	
059	*****	*****	***	*****
060	266326-2	TAPPING SCREW 4X18	2	
061	345651-5	SPIKE BUMPER	1	
062	188089-9	HOUSING SET	1	

SPARE PARTS LIST

MODEL NO. UC3520A

ITEM	PART NO.	DESCRIPTION	QTY	NOTE
		INC. 11		
063	266326-2	TAPPING SCREW 4X18	7	
064	221526-1	SPROCKET	1	
065	259036-8	STOP RING E-8	1	
066	266007-8	TAPPING SCREW BIND PT 3X10	1	
067	419241-1	COVER	1	
068	227496-2	STRAIGHT BEVEL GEAR 14	1	
069	227495-4	STRAIGHT BEVEL GEAR 14	1	
070	324620-9	ADJUST SCREW	1	
071	324621-7	ADJUST PIN	1	
072	165246-6	GUIDE BAR	1	
073	233033-2	COMPRESSION SPRING 4	1	
074	216008-6	STEEL BALL 4	1	
075	252168-0	HEX. NUT M8-13	1	
076	231025-5	COMPRESSION SPRING 8	1	
077	317977-5	LEVER HOLDER	1	
078	419271-2	CUP WASHER 20	1	
079	154763-1	LEVER COMPLETE	1	
080	951122-8	SPRING PIN 4-28	1	
081	915106-0	BINDING HEAD SCREW M4X8	1	
082	253874-0	FLAT WASHER 4	1	
083	419233-0	DIAL 40	1	
084	154761-5	SPROCKET COVER COMPLETE	1	
085	421960-7	SPONGE	1	
086	324685-1	HOSE CLAMP	1	
087	443125-1	FILTER	1	
088	259041-5	PUSH NUT 8	1	
A01	158024-1	HOOK COMPLETE	1	
A02	419288-5	CHAIN COVER	1	
A03	803894-0	UC3520A CARTON LABEL	1	

SERVICE DRAWING

MODEL NO. UC3520A

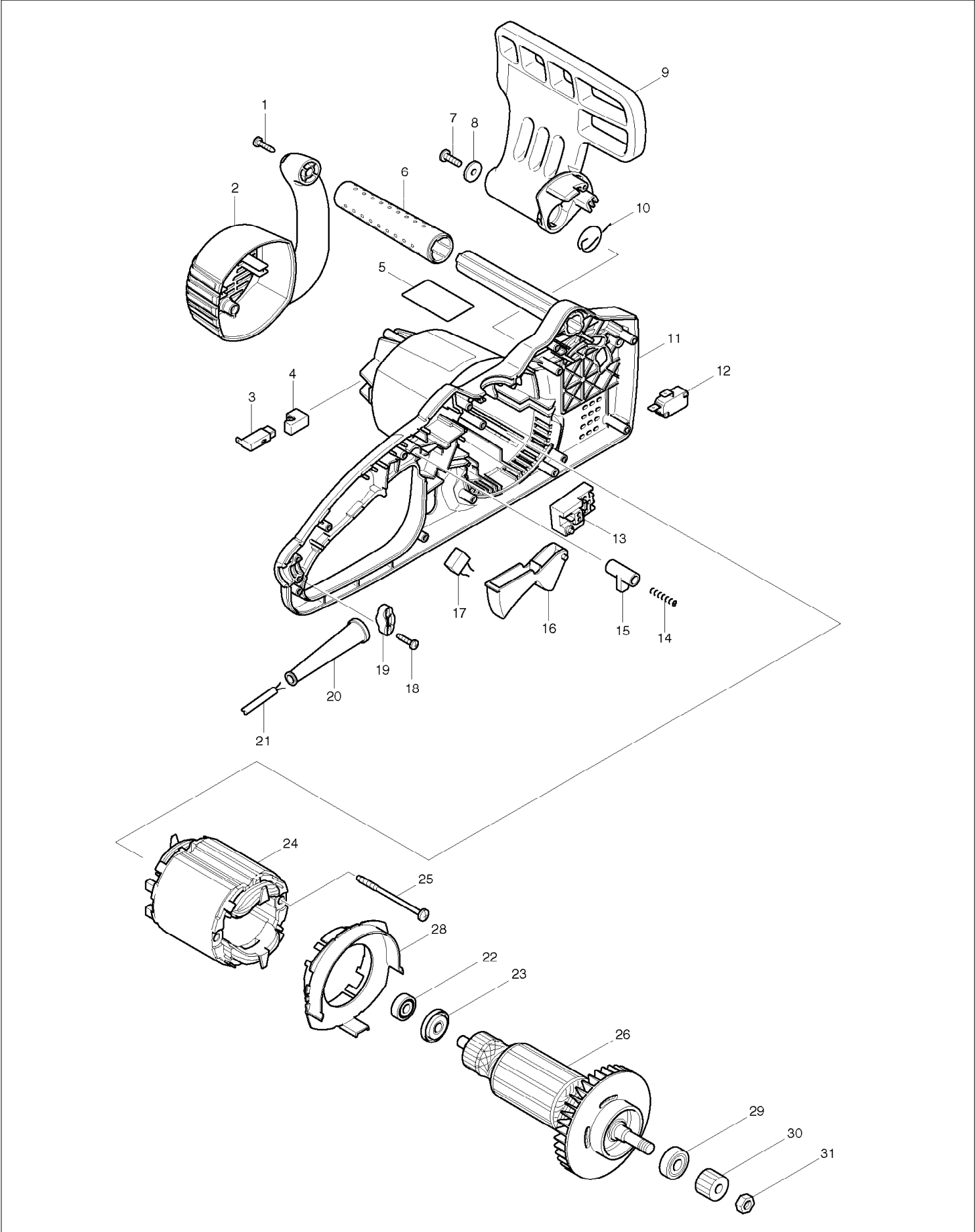

SERVICE DRAWING

MODEL NO. UC3520A

