

# Model No. DTL061 CORDLESS ANGLE IMPACT DRIVER

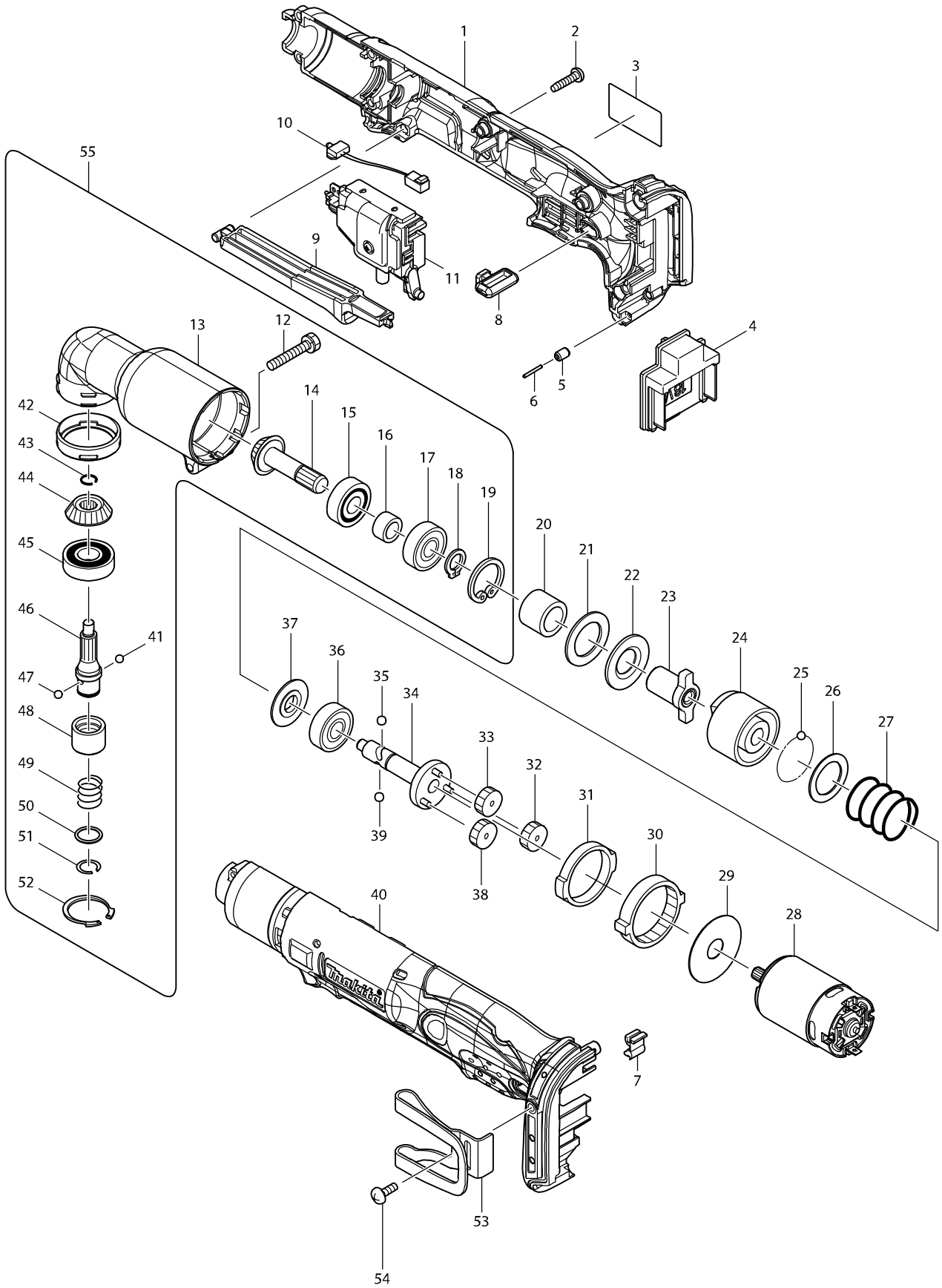

# Model No. DTL061 CORDLESS ANGLE IMPACT DRIVER

Item	Parts No.	Description	I/C	Qty	N/O	Opt. 1	Opt. 2	Note
001	188397-8	HOUSING SET		1				
C10	263005-3	RUBBER PIN 6		2				
D10		INC. 40						
002	265995-6	TAPPING SCREW 4X18		8				
003	815M16-8	DTL061 NAME PLATE		1				
004	643852-2	TERMINAL		1				
005	263036-2	RUBBER PIN 5		1				
006	268184-2	PIN 1.5		1				
007	424026-2	CUSHION		1				
008	450126-2	FR CHANGE LEVER		1				
009	450125-4	SWITCH LEVER		1				
010	631778-0	LED CIRCUIT		1				
011	638885-0	SWITCH UNIT		1				
012	265409-5	+ HEX. BOLT M5X30		1				
013	152461-1	ANGLE HEAD COMPLETE		1				
014	226720-0	ZEROL BEVEL GEAR 13		1				
015	211064-1	BALL BEARING 6000		1				
016	257660-1	SLEEVE 10		1				
017	211061-7	BALL BEARING 6000LLB		1				
018	961006-2	RETAINING RING S-10		1				
019	962105-3	RETAINING RING R-26		1				
020	257662-7	SLEEVE 15		1				
021	261095-0	RUBBER WASHER 21		1				
022	267120-5	FLAT WASHER 15		1				
023	322689-7	ANVIL		1				
024	322688-9	HAMMER		1				
025	216001-0	STEEL BALL 3.5		22				
026	267121-3	FLAT WASHER 20		1				
027	233107-9	COMPRESSION SPRING 22		1				
028	629846-1	DC MOTOR		1				
029	267053-4	FLAT WASHER 12		1				
030	226280-2	INTERNAL GEAR 69		1				
031	257187-1	RING 32		1				
032	226279-7	SPUR GEAR 29		1				
033	226279-7	SPUR GEAR 29		1				
034	154416-2	SPINDLE COMPLETE		1				
035	216002-8	STEEL BALL 4.8		1				
036	211064-1	BALL BEARING 6000		1				
037	322719-4	WASHER 10		1				
038	226279-7	SPUR GEAR 29		1				
039	216002-8	STEEL BALL 4.8		1				
040	188397-8	HOUSING SET		1				
C10	263005-3	RUBBER PIN 6		2				
D10		INC. 1						
041	216001-0	STEEL BALL 3.5		1				
042	424044-0	RUBBER RING 32		1				
043	231990-8	RING SPRING 9		1				
044	226721-8	ZEROL BEVEL GEAR 13		1				

